

RELY ON EXCELLENCE

## M481K

Mechanical Seals | Agitator seals | Liquid lubricated seals

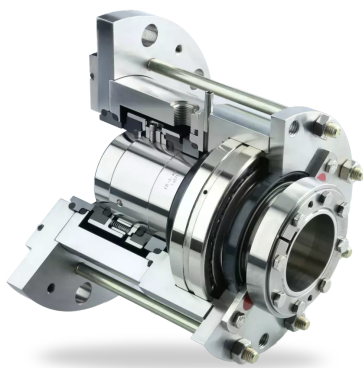

### Features

- Liquid-lubricated double seal for top-entry drives
- Cartridge unit
- Self-closing on the product side
- For stepped and unstepped shafts
- Unbalanced
- Independent of direction of rotation
- Multiple springs rotating

### Notes

Options:

- Cooling resp. heating flange
- Leakage drain
- Flush
- Polymerization barrier
- Axial expansion joint (shaft movement)
- Wiper ring (shaft movement)

Please inquire.

### Advantages

- Ready-to-fit and factory-tested units
- The M481K and its variants will remain closed even during pressure variations or pressure reversal. Operation is possible with buffer fluid ( $p_{1max} = 6 \text{ bar (87 PSI)}$ ) or pressurized with barrier fluid as double seal
- Available with or without bearing
- Suitable for standardizations
- Seal can be applied at higher pressure and rotating speed than specified by DIN

### Operating range

Shaft diameter:

$d_1 = 40 \dots 220 \text{ mm (1.57" \dots 8.66")}$

Pressure:

$p_1 = \text{vacuum} \dots 16 \text{ bar (232 PSI)}$ ,

$p_3 = \text{max. } 18 \text{ bar (261 PSI)}$

Temperature:

$t_1 = -40 \text{ °C} \dots +200 \text{ (350*) °C}$   
 $(-40 \text{ °F} \dots +392 \text{ (662*) °F})$

Sliding velocity:

$vg = 0 \dots 5 \text{ m/s (0 \dots 16 ft/s)}$

For applications beyond this range, please inquire.

\* with cooling flange

! It should be noted that the extremal values of each operating parameter cannot be applied at the same time because of their interaction.

### Materials

Seal faces: Carbon graphite or Silicon carbide, FDA conform

Seats: Silicon carbide, FDA conform

Secondary seals and metallic parts acc. to application and customers' requirement

### Standards and approvals

- FDA
- ATEX
- DIN 28138 (mechanical seals for agitator shafts)
- DIN 28136 T2 (for steel vessels)
- DIN 28141 (flange connection for steel vessels)
- DIN 28154 (shaft end for steel vessels)
- Compliant to TA Luft (German Clean Air Act)

### Recommended applications

- Refining technology
- Petrochemical industry
- Chemical industry
- Pharmaceutical industry
- Food and beverage industry
- Agitators
- Reactors

### Recommended piping plans

Closed circuit EagleBurgmann TS system, open circuit EagleBurgmann SPA, SPN

Product links:

[EagleBurgmann TS1000](#)

[EagleBurgmann TSA2](#)

[EagleBurgmann SPA](#)

[EagleBurgmann SPN manual](#)

[EagleBurgmann SPN automatic](#)

**RELY ON EXCELLENCE**

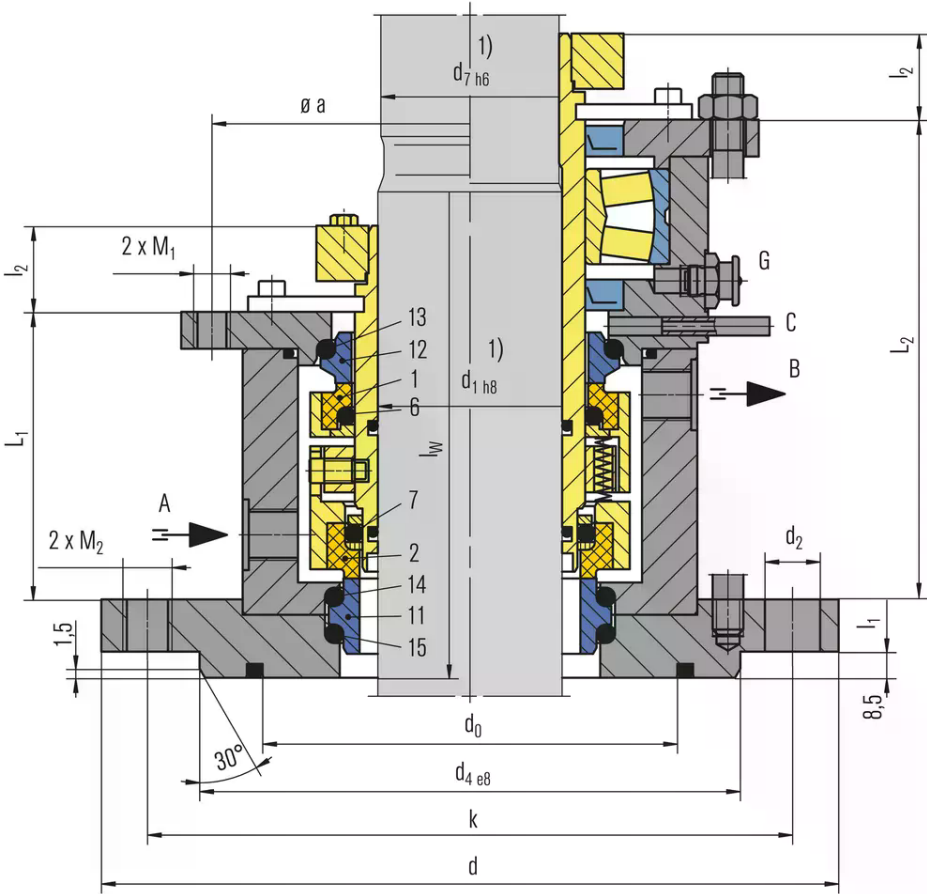

Item	Description
1	Seal face, atmosphere side
2	Seal face, product side
6, 7, 13, 14, 15	O-Ring
11	Seat, product side
12	Seat, atmosphere side

RELY ON EXCELLENCE

## Torque transmissions

Shrink disk

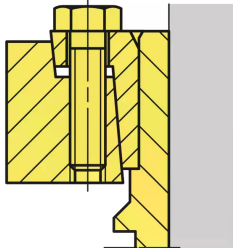

Clamping ring with pin

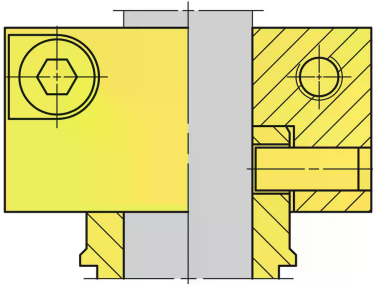

Clamping ring

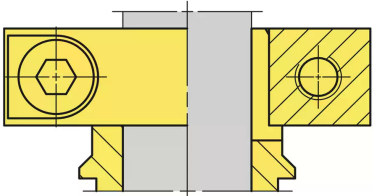

RELY ON EXCELLENCE

## Installation, details, options

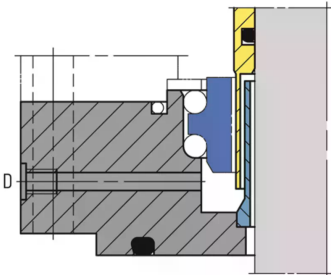

**Polymerization barrier**  
Can be used alternatively as a leakage drain or a flush.

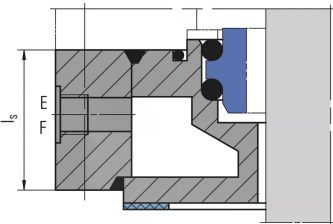

**Cooling flange**  
Can be used alternatively as a heating flange.

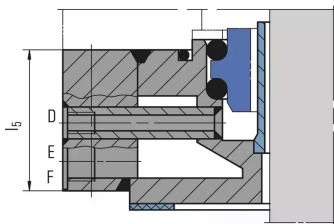

**Leakage drain with cooling flange**  
Can be used alternatively as a flush or as a heating flange.

## RELY ON EXCELLENCE

### Leakage drain

Can be used alternatively as a flush.

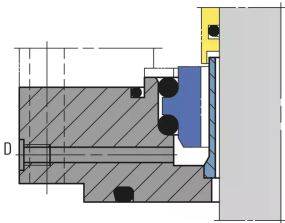

### Flush

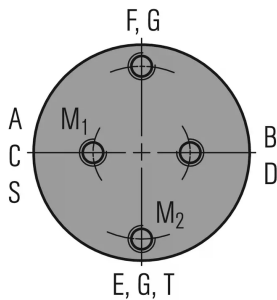
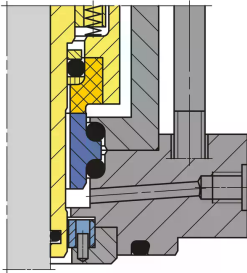

### Supply connections

Designation and position acc. to DIN 28138 T3.

- A Supply liquid IN
- B Supply liquid OUT
- C Drainage
- D Leakage drain
- E Cooling IN
- F Cooling OUT
- G Grease
- S Flush
- T Temperature metering

For reasons of standardization, the supply connections of single seals are matched to those of the double seals (in deviation from DIN 28138 T3).

## Product variants

### M481KL

Variant with integrated floating bearing

### M451K

Variant for unstepped shafts or customer-specific connection dimensions. The seal is available for any diameter. Further customer-specific adaptations are also possible.

## RELY ON EXCELLENCE

### Dimensions

d <sub>1</sub> )	d <sub>7</sub> )	d	n x d <sub>2</sub>	d <sub>4</sub>	d <sub>0</sub>	k	L <sub>1</sub>	L <sub>2</sub>	L <sub>w</sub> 2)	l <sub>1</sub>	l <sub>2</sub>	A	M <sub>1</sub>	M <sub>2</sub>	A, B
40	38	175	4x18	110	90	145	87	136	143	15	28	122	M12	M16	G3/8
50	48	240	8x18	176	135	210	89	149	148	17	28	157	M12	M16	G3/8
60	58	240	8x18	176	135	210	93.5	156	158	17	28	168	M12	M16	G3/8
80	78	275	8x22	204	155	240	104.5	189	168	20	34	203	M16	M20	G1/2
100	98	305	8x22	234	190	270	109	190	178	20	34	228	M16	M20	G1/2
125	120	330	8x22	260	215	295	110	205	203	20	40	268	M20	M20	G1/2
140	135	395	12x22	313	250	350	124	222	208	20	40	285	M20	M20	G1/2
160	150	395	12x22	313	265	350	127.5	219.5	213	25	40	297	M20	M20	G1/2
180	170	445	12x22	364	310	400	132.5	230	233	25	45	332	M24	M20	G1/2
200	190	445	12x22	364	310	400	137.5	237.5	243	25	45	352	M24	M20	G1/2
220	210	505	16x22	422	340	460	149.5	249.5	263	25	50	381	M24	M20	G1/2

Dimensions in millimeter 1) Shaft diameters d~1~ and d~7~ to DIN 28154 2) Shaft step to DIN 28154